

FR 777

| | |
|--------------------|---|
| SLIDE TYPE: | Progressive action full-extension pantry pull-out slide with top slide |
| MOUNTING: | Floor Mount |

| | |
|-----------------------|---------------------------------|
| WIDTH: | 125 mm (4.92 in.) |
| LOAD CAPACITY: | dynamic up to 200 kg (450 lbs.) |

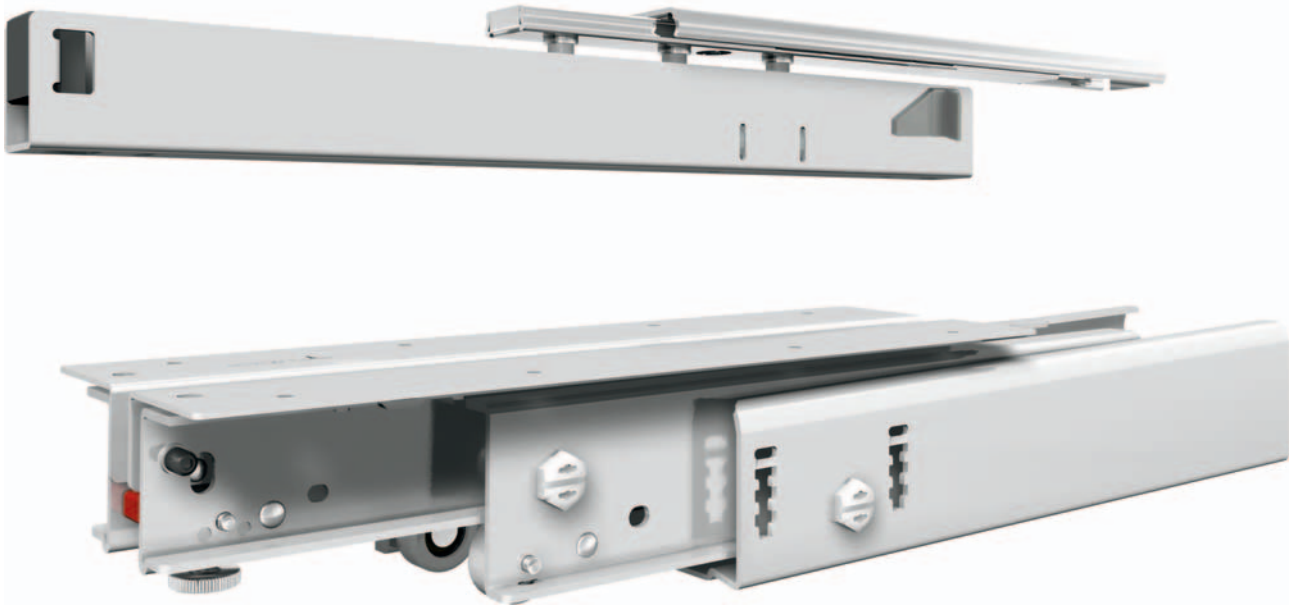

| | |
|------------------|---|
| MATERIAL: | top slide: steel, zinc plated bottom slide: steel, white powder coated |
|------------------|---|

| | |
|------------------|--|
| FEATURES: | solid delrin* rollers, delrin*- encased steel ball bearings |
|------------------|--|

| | |
|------------------------|--|
| SPECIFICATIONS: | <ul style="list-style-type: none"> ▶ quick and easy installation ▶ quiet movement, even under the heaviest loads ▶ horizontal and vertical adjustment ▶ top slide for absolute lateral stability ▶ LGA-tested according to DIN 4554 standard at 50,000 double cycles ▶ back stop |
|------------------------|--|

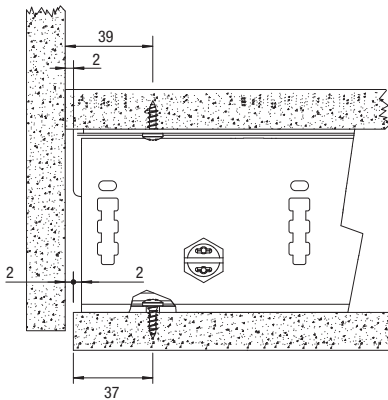
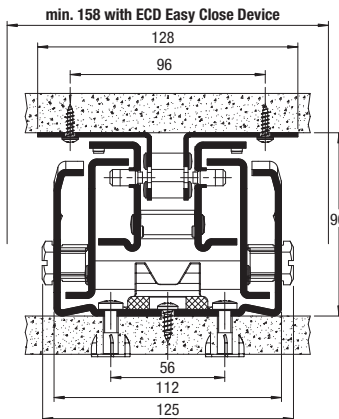
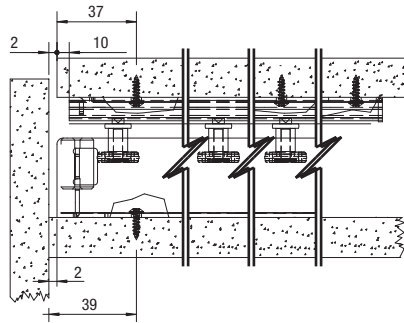
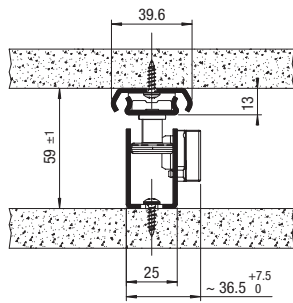

| | |
|---------------|---|
| NOTES: | <ul style="list-style-type: none"> ▶ also available as FR777.ECD with easy close device (ECD) integrated (top and bottom slide) ▶ Do not lubricate any part of the slide! ▶ recommended maximum cabinet height: 2500mm (98.43 in.) ▶ recommended maximum cabinet width: 600mm (23.62 in.) |
|---------------|---|

*DuPont (TM) Delrin®

FR 777

| | |
|--------------------|---|
| SLIDE TYPE: | Progressive action full-extension pantry pull-out slide with top slide |
| MOUNTING: | Floor Mount |

| | |
|-----------------------|---------------------------------|
| WIDTH: | 125 mm (4.92 in.) |
| LOAD CAPACITY: | dynamic up to 200 kg (450 lbs.) |

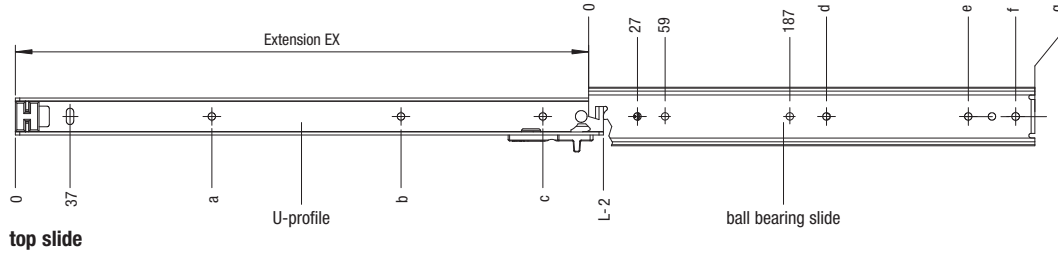

| Length L | | Extension EX | | a | | b | | c | | L-2 | | d | | e | | f | | g | |
|----------|-------|--------------|-------|-----|-------|-----|-------|------|-------|------|-------|-----|------|-----|-------|-----|-------|-----|-------|
| mm | in | mm | in | mm | in | mm | in | mm | in | mm | in | mm | in | mm | in | mm | in | mm | in |
| 400 | 15.74 | 384 | 15.12 | 133 | 5.24 | 261 | 10.28 | 357 | 14.06 | 398 | 15.67 | 155 | 6.10 | 251 | 9.88 | 283 | 11.14 | 296 | 11.65 |
| 450 | 17.72 | 434 | 17.09 | 133 | 5.24 | 261 | 10.28 | 421 | 16.57 | 448 | 17.64 | 155 | 6.10 | 251 | 9.88 | 283 | 11.14 | 296 | 11.65 |
| 500 | 19.69 | 484 | 19.06 | 165 | 6.50 | 325 | 12.80 | 453 | 17.83 | 498 | 19.61 | 219 | 8.62 | 347 | 13.66 | 379 | 14.92 | 392 | 15.43 |
| 550 | 21.65 | 534 | 21.02 | 197 | 7.76 | 357 | 14.06 | 517 | 20.35 | 548 | 21.57 | 219 | 8.62 | 347 | 13.66 | 379 | 14.92 | 392 | 15.43 |
| 600 | 23.62 | 584 | 22.99 | 197 | 7.76 | 389 | 15.31 | 549 | 21.61 | 598 | 23.54 | 219 | 8.62 | 347 | 13.66 | 379 | 14.92 | 392 | 15.43 |
| 650 | 25.59 | 634 | 24.96 | 229 | 9.02 | 421 | 16.57 | 613 | 24.13 | 648 | 25.51 | 219 | 8.62 | 347 | 13.66 | 379 | 14.92 | 392 | 15.43 |
| 700 | 27.55 | 684 | 26.93 | 261 | 10.28 | 485 | 19.09 | 645 | 25.39 | 698 | 27.48 | 219 | 8.62 | 347 | 13.66 | 379 | 14.92 | 392 | 15.43 |
| 750 | 29.53 | 734 | 28.90 | 261 | 10.28 | 485 | 19.09 | 709 | 27.91 | 748 | 29.45 | 219 | 8.62 | 347 | 13.66 | 379 | 14.92 | 392 | 15.43 |
| 800 | 31.50 | 784 | 30.87 | 293 | 11.54 | 549 | 21.61 | 773 | 30.43 | 798 | 31.42 | 219 | 8.62 | 347 | 13.66 | 379 | 14.92 | 392 | 15.43 |
| 850 | 33.47 | 834 | 32.83 | 293 | 11.54 | 549 | 21.61 | 805 | 31.69 | 848 | 33.39 | 219 | 8.62 | 347 | 13.66 | 379 | 14.92 | 392 | 15.43 |
| 900 | 35.43 | 884 | 34.80 | 325 | 12.80 | 581 | 22.87 | 869 | 34.21 | 898 | 35.35 | 219 | 8.62 | 347 | 13.66 | 379 | 14.92 | 392 | 15.43 |
| 950 | 37.40 | 934 | 36.77 | 325 | 12.80 | 613 | 24.13 | 901 | 35.47 | 948 | 37.32 | 219 | 8.62 | 347 | 13.66 | 379 | 14.92 | 392 | 15.43 |
| 1000 | 39.37 | 984 | 38.74 | 325 | 12.80 | 645 | 25.39 | 965 | 38.00 | 998 | 39.29 | 219 | 8.62 | 347 | 13.66 | 379 | 14.92 | 392 | 15.43 |
| 1100 | 43.31 | 1084 | 42.68 | 389 | 15.31 | 741 | 29.17 | 1061 | 41.77 | 1098 | 43.23 | 219 | 8.62 | 347 | 13.66 | 379 | 14.92 | 392 | 15.43 |

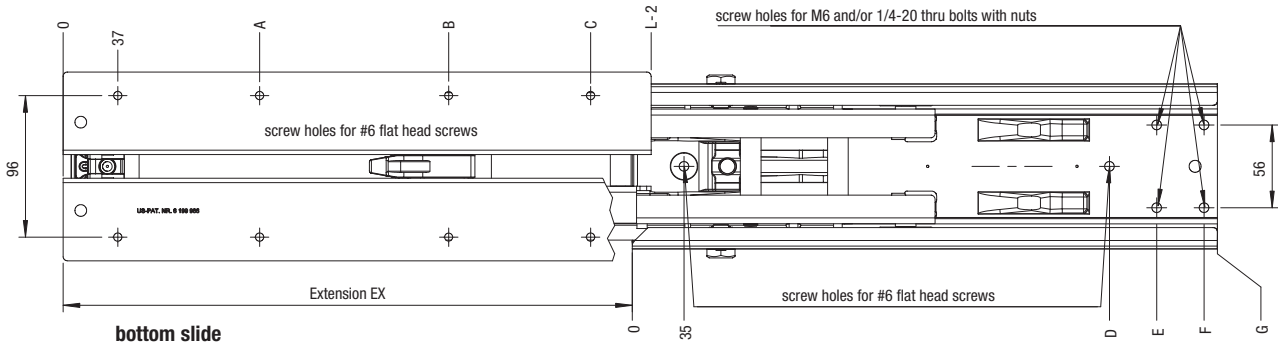

| Length L | | Extension EX | | A | | B | | C | | L-2 | | D | | E | | F | | G | | Weight per set | | Order No. |
|----------|-------|--------------|-------|-----|-------|-----|-------|------|-------|------|-------|-----|-------|------|-------|------|-------|-------|-------|----------------|-----|-----------|
| mm | in | mm | in | mm | in | mm | in | mm | in | mm | in | mm | in | mm | in | mm | in | mm | in | kg | lbs | white |
| 400 | 15.74 | 384 | 15.12 | 133 | 5.24 | 261 | 10.28 | 357 | 14.06 | 398 | 15.67 | 355 | 13.98 | 387 | 15.24 | 396 | 15.59 | 9.31 | 20.53 | | | 7720 |
| 450 | 17.72 | 434 | 17.09 | 133 | 5.24 | 261 | 10.28 | 421 | 16.57 | 448 | 17.64 | 387 | 15.24 | 419 | 16.50 | 446 | 17.56 | 10.30 | 22.71 | | | 7721 |
| 500 | 19.69 | 484 | 19.06 | 165 | 6.50 | 325 | 12.80 | 453 | 17.83 | 498 | 19.61 | 419 | 16.50 | 451 | 17.76 | 496 | 19.53 | 11.32 | 24.96 | | | 7722 |
| 550 | 21.65 | 534 | 21.02 | 197 | 7.76 | 357 | 14.06 | 517 | 20.35 | 548 | 21.57 | 483 | 19.02 | 515 | 20.28 | 546 | 21.50 | 12.39 | 27.32 | | | 7723 |
| 600 | 23.62 | 584 | 22.99 | 197 | 7.76 | 389 | 15.31 | 549 | 21.61 | 598 | 23.54 | 515 | 20.28 | 547 | 21.54 | 596 | 23.46 | 13.36 | 29.45 | | | 7724 |
| 650 | 25.59 | 634 | 24.96 | 229 | 9.02 | 421 | 16.57 | 613 | 24.13 | 648 | 25.51 | 579 | 22.80 | 611 | 24.06 | 646 | 25.43 | 14.55 | 32.08 | | | 7725 |
| 700 | 27.55 | 684 | 26.93 | 261 | 10.28 | 485 | 19.09 | 645 | 25.39 | 698 | 27.48 | 547 | 21.54 | 611 | 24.06 | 643 | 25.31 | 15.46 | 34.08 | | | 7726 |
| 750 | 29.53 | 734 | 28.90 | 261 | 10.28 | 485 | 19.09 | 709 | 27.91 | 748 | 29.45 | 579 | 22.80 | 675 | 26.57 | 707 | 27.83 | 16.45 | 36.27 | | | 7727 |
| 800 | 31.50 | 784 | 30.87 | 293 | 11.54 | 549 | 21.61 | 773 | 30.43 | 798 | 31.42 | 643 | 25.31 | 739 | 29.09 | 771 | 30.35 | 17.67 | 38.96 | | | 7728 |
| 850 | 33.47 | 834 | 32.83 | 293 | 11.54 | 549 | 21.61 | 805 | 31.69 | 848 | 33.39 | 675 | 26.57 | 771 | 30.35 | 803 | 31.61 | 18.65 | 41.12 | | | 7729 |
| 900 | 35.43 | 884 | 34.80 | 325 | 12.80 | 581 | 22.87 | 869 | 34.21 | 898 | 35.35 | 707 | 27.83 | 835 | 32.87 | 867 | 34.13 | 19.64 | 43.30 | | | 7730 |
| 950 | 37.40 | 934 | 36.77 | 325 | 12.80 | 613 | 24.13 | 901 | 35.47 | 948 | 37.32 | 739 | 29.09 | 867 | 34.13 | 899 | 35.39 | 20.63 | 45.48 | | | 7731 |
| 1000 | 39.37 | 984 | 38.74 | 325 | 12.80 | 645 | 25.39 | 965 | 38.00 | 998 | 39.29 | 771 | 30.35 | 931 | 36.65 | 963 | 37.91 | 21.11 | 46.54 | | | 7732 |
| 1100 | 43.31 | 1084 | 42.68 | 389 | 15.31 | 741 | 29.17 | 1061 | 41.77 | 1098 | 43.23 | 867 | 34.13 | 1027 | 40.43 | 1059 | 41.69 | 23.10 | 50.93 | | | 7733 |

Packing: 1 set per box (bottom slide, top slide) with instructions

*DuPont (TM) Delrin®

FR 777

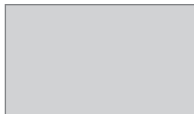

Fulterer